

CASEMENT 30.5 WALL CHART

OUTER FRAMES & SASH

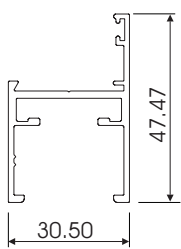

W27990

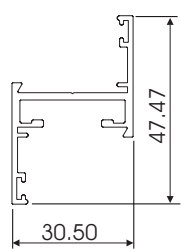

W27992

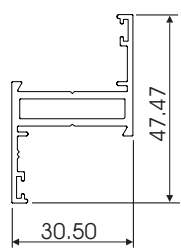

W53631

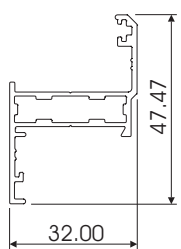

W55441

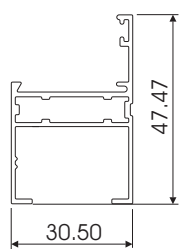

W55009

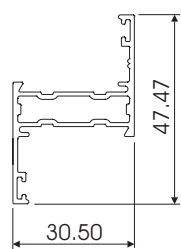

W50959

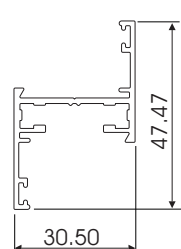

W32027

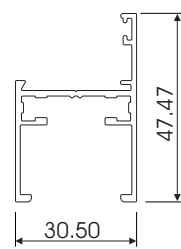

W32028

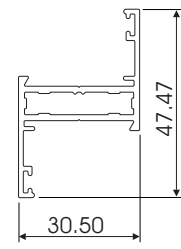

W55684

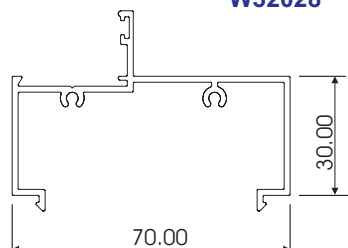

W70968

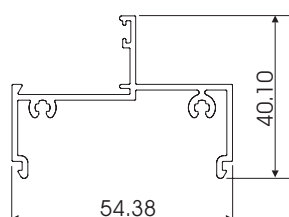

W28481

MULLIONS

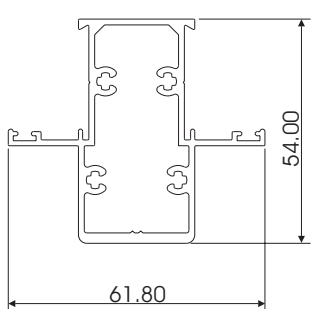

W54651

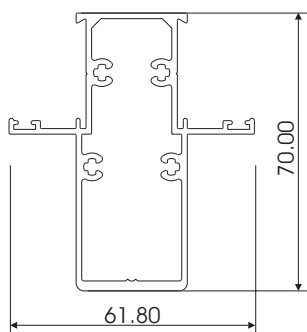

W54652

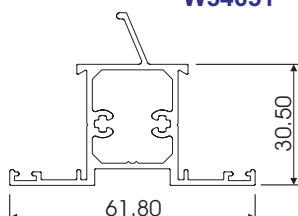

W53630

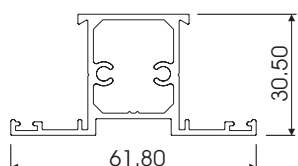

W53629

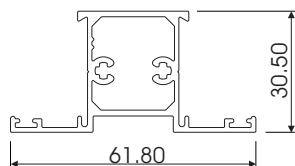

W55685

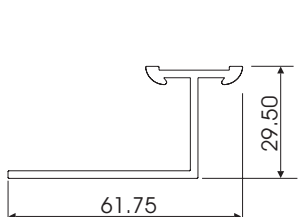

W28002
GLAZING BEADS

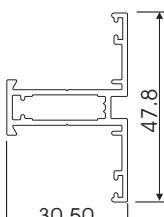

W54867

CORNER CLEAT

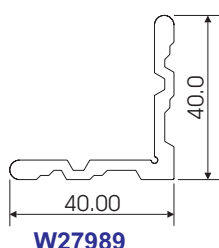

W27989

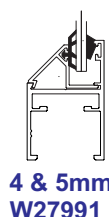

4 & 5mm
W27991

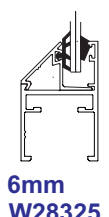

6mm
W28325

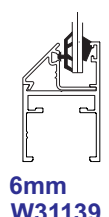

6mm
W31139

Standard Assembly

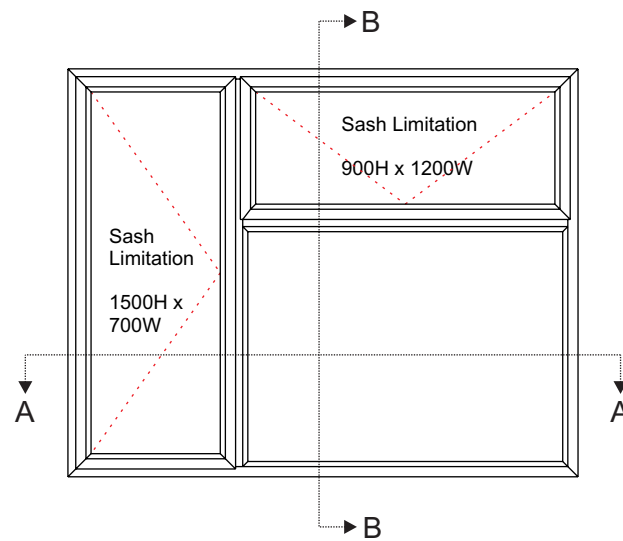

SECTION B - B

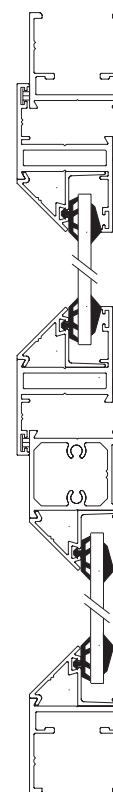

SECTION A - A

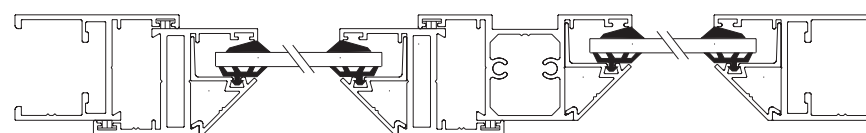

Heavy Duty Assembly

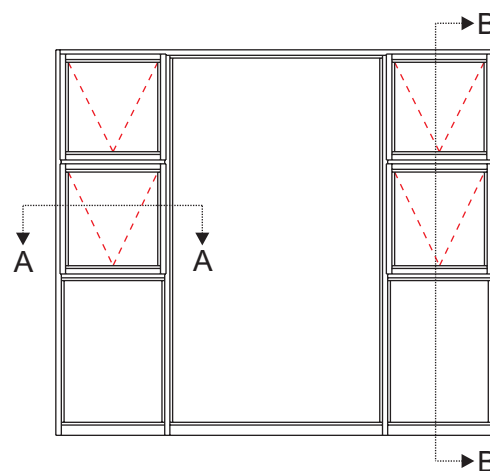

SECTION B - B

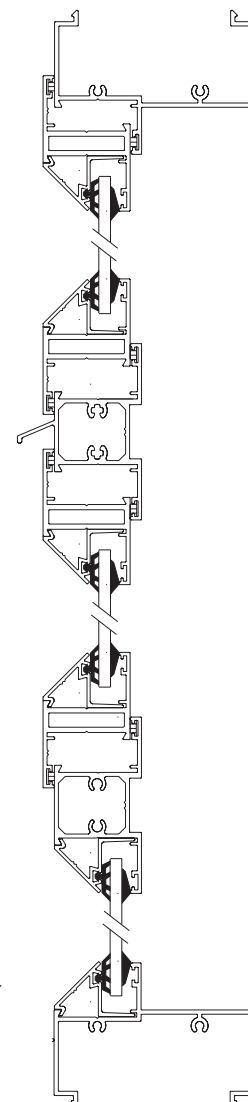

SECTION A - A

